



evolum

SENCILLEZ Y VERSATILIDAD
SIMPLICITY AND VERSATILITY
SIMPLICIDADE E VERSATILIDADE

2008





— |

| —



— |

| —

evolum

SENCILLEZ Y VERSATILIDAD

SIMPLICITY AND VERSATILITY

SIMPLICIDADE E VERSATILIDADE





evolum

■ ■
Evolum es la nueva marca de Idónea que va a dar vida a un sistema de estanterías que, por su diversidad e infinitas posibilidades, constituyen la herramienta perfecta para elaborar diferentes mobiliarios y la creación de todo tipo de espacios: salones, librerías, armarios, vestidores, oficinas, mesas, instalaciones comerciales...

De gran valor estético y diseño original, el Sistema Evolum resulta sencillo y de fácil montaje. Con una pequeña inversión y buenas ideas podrá obtener resultados realmente sorprendentes.

■ ■
Evolum is the new Idonea's trade mark which is going to create a system of shelves that, due to their diversity and endless possibilities represent the perfect tool to elaborate diverse furniture and the design of all kind of spaces: living rooms, bookcases, closets, dressing rooms, offices, tables, commercial facilities...

With a great aesthetic and original design, the Evolum System is simple and easy to assemble. With a minimum investment and good ideas you could obtain surprising results.

■ ■
Evolum é a nova marca de Idónea que vai dar vida a um sistema de estantes que, por sua diversidade e infinitas possibilidades, constituem a ferramenta perfeita para elaborar diferentes mobiliários e a criação de todo o tipo de espaços:
Salas, livrarias, roupeiros, vestuários, escritórios, mesas, instalações comerciais...

De grande valor estético e design original, o Sistema Evolum é simples e de fácil montagem. Com pouco investimento e boas ideias poderá obter resultados realmente surpreendentes.



evolum_superficies comerciales
evolum_commercial facilities
evolum_superfícies comerciais

| evolum_superficies comerciales | evolum_commercial facilities | evolum_superfícies comercials |

IDÓ NEA FASHION





evolum_superficies comerciales

El Sistema Evolum superficies comerciales destaca por su funcionalidad y adaptabilidad. Soporta el uso día a día con perfiles mínimos y puede desdoblarse en muebles para almacenaje, exposición... con infinidad de tamaños y disposiciones.

evolum_commercial facilities

The Evolum System commercial facilities stands out due to its functionality and adaptability. It supports the daily use with minimum profiles and its utility is multiple such as storage, exhibition... with a large variety of measures and arrangements.

evolum_superfícies comerciais

O Sistema Evolum superfícies comercial destaca-se pela sua funcionalidade e adaptabilidade. Suporta o uso no dia-a-dia com um mínimo de perfis e pode desdobrar-se em móveis para armazenagem, exposição... com uma infinidade de tamanhos e disposições.





_funcionalidad y adecuación a su espacio al mejor coste
_functionality and adaptability to your space for an economic price
_funcionalidade e versatilidade ao seu espaço ao melhor preço



Espacios actuales, ligeros y funcionales que garantizan la creación de superficies comerciales sencillas, cómodas y con una estética muy actual.
Modern, light and functional spaces that guarantee the creation of simple, comfortable commercial facilities with a very fresh aesthetic.
Espaços atualizados, leves e funcionais que garantem a criação de superfícies comerciais simples, confortáveis e com uma estética muito atual.



| evolum_superficies comerciales | evolum_commercial facilities | evolum_superfícies comercials |





evolum_superficies comerciales

Evolum contempla la opción de crear muebles en esquina, sacándole de este modo el máximo rendimiento a su espacio.

Además la simplicidad de sus líneas y el concepto modular del espacio, hacen que el producto expuesto sea el verdadero protagonista.

evolum_commercial facilities

Evolum offers the chance of creating corner shelves, which allows to make a better use of the available space.

Furthermore evolum simple lines and modular concept emphasize your product importance.

evolum_superfícies comerciais

Evolum completa a opção de criar móveis em esquina, tirando deste modo o máximo rendimento ao seu espaço.

Sobretudo a simplicidade das suas linhas e o conceito modular do espaço, fazem com que o produto exposto seja o verdadeiro protagonista.



| evolum_superficies comerciales | evolum_commercial facilities | evolum_superfícies comerciais |

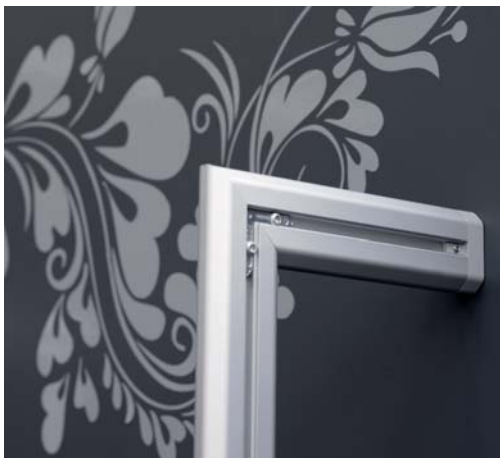

_máximo cuidado por la estética y el detalle
_the highest care in design and detail
_máximo cuidado pela estética e o detalhe



Sistema resistente de gran durabilidad y fácil mantenimiento.
Strong, lasting and easy maintenance system.
Sistema de grande durabilidade e fácil manuseamento.



| evolum_superficies comerciales | evolum_commercial facilities | evolum_superfícies comerciais |





evolum_superficies comerciales

Las infinitas posibilidades de sus baldas; posibilidad de inclinarse, utilización de soportes como reclamo publicitario, posibilidad de incluir iluminación... hacen que el sistema Evolum se adapte a sus necesidades y a las de su espacio.

evolum_commercial facilities

Shelves with endless possibilities; Tilt over feature, lighting option which can be used as advertising appeal... allows you to adapt evolum to your needs and available space.

evolum_superfícies comerciais

As infinitas possibilidades de suas prateleiras; Possibilidade de se inclinar, utilização de suportes como reclames publicitários, possibilidade de incluir iluminação... fazem com que o sistema Evolum se adapte às suas necessidades e às do seu espaço.





_excelentes remates y terminaciones que se integran a la perfección en el conjunto
_excellent ornamental tops and finishing perfectly adapted to the suite
_excelentes remates e terminações que se integram á perfeição no conjunto



Creación de espacios prácticos y funcionales con gran capacidad de almacenamiento y exposición de producto.
Practical and functional spaces creation with great storage and product exhibition capacity.
Criação de espaços práticos e funcionais com grande capacidade de armazenamento e exposição de produto.





evolum_salón
evolum_lounge
evolum_sala

| evolum_salón | evolum_lounge | evolum_sala |





evolum_salón

Versátil, ligero y elegante, Evolum puede dar lugar a un espacio cómodo y sencillo. Aparadores, estanterías abiertas... infinidad de soluciones dotadas de un gran valor estético y funcional que hacen de su salón un lugar práctico y a su medida.

evolum_lounge

Versatile, light and sophisticated, Evolum gives way to a comfortable and simple space. Sideboards, open shelves... with multiple solutions full of a great aesthetic and functional value which transform your living room into a practical and customized place.

evolum_sala

Versátil, práctico e elegante, Evolum pode dar lugar a um espaço confortável e simples. Aparadores, estantes abertas... uma infinidade de soluções dotadas de grande valor estético e funcional que fazem da sua sala um lugar prático e à sua medida.



| evolum_salón | evolum_lounge | evolum_sala |

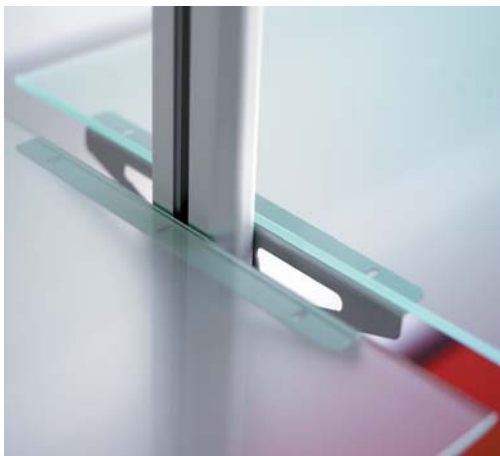

_sencillez y elegancia para proporcionarle el máximo confort
_simplicity and elegance, a perfect combination to provide you the maximum comfort
_simplicidade e elegância para lhe proporcionar o máximo de conforto



Como el resto de soluciones Evolum, los acabados y los materiales pueden combinarse libremente, siendo este el elemento clave para la personalización y exclusividad de su espacio.
Like the rest of Evolum solutions, the finishing and materials can be combined freely, turning into the key element for personalization and exclusivity in your space.
Como todas as soluções Evolum, os acabamentos e os materiais podem ser combinados livremente, sendo este o elemento chave para a personalização e exclusividade do seu espaço.



| evolum_salón | evolum_lounge | evolum_sala |



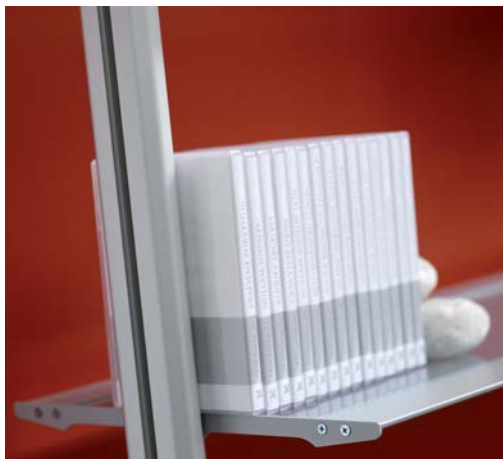

_posibilidad de combinar distintos materiales y acabados en sus espacios
_Evolum offers the possibility of mixing different materials and finishing in your personal space
_possibilidade de combinar diferentes materiais e acabamentos em seus ambientes





evolum_vestidor
evolum_dressing room
evolum_vestiário

| evolum_vestidor | evolum_dressing room | evolum_vestiário |





evolum_vestidor

El aprovechamiento del espacio es máximo con nuestro sistema Evolum, permitiendo la organización que más se adapte a usted. Los elementos intercambiables hacen que además sea un espacio vivo que puede transformarse.

evolum_dressing room

The use of your space can be improved by our Evolum system, this system allows you to adapt the space organisation to your needs. Interchangeable parts allow you to transform the space as per your needs.

evolum_vestiário

O aproveitamento do espaço é máximo com nosso sistema Evolum, permitindo a organização que mais se adapte a si. Os elementos intercambiáveis fazem com que além disso seja um espaço vivo que pode transformar-se.



| evolum_vestidor | evolum_dressing room | evolum_vestiário |



_materiales resistentes que dan respuesta a los más exigentes
_resistant materials able to satisfy your highest requirements
_materiais resistentes que dão resposta aos mais exigentes



Espacios funcionales y con gran personalidad en los que prima el cuidado por el detalle.
Strong personality and functional spaces in which stands out the care of the details.
Espaços funcionais e com grande personalidade nos que primam o cuidado pelo detalhe.



| evolum_vestidor | evolum_dressing room | evolum_vestiário |





evolum_vestidor

Evolum le permite crear un vestidor adaptado a usted. Mayor superficie para colgar, más baldas o mayor espacio para su calzado... adaptabilidad y flexibilidad para satisfacer cualquier necesidad. Además, con un sencillo y rápido montaje podrá llevar a cabo todo aquello que pueda imaginar.

evolum_dressing room

Evolum allow you to create a dressing room personally adapted. More hanging space, more shelves or more space for your footwear... adaptability and flexibility to satisfy your needs. Furthermore due to evolum easy assembling system you'll be able to built anything you may need.

evolum_vestiário

Evolum permite-lhe criar um vestiário adaptado a si. Maior superfície para colocar, mais prateleiras ou maior espaço para seu calçado... adaptabilidade e flexibilidade para satisfazer qualquer necessidade. Além disso com uma simples e rápida montagem poderá levar a cabo todo o que possa imaginar.



| evolum_vestidor | evolum_dressing room | evolum_vestiário |



_adaptabilidad y personalización para que su espacio sea único
_adapt and customize your space to make it unique
_adaptabilidade e personalização para que o seu espaço seja único



Fácil y sencillo en su montaje, Evolum le da libertad para adaptar su vestidor a unas necesidades muy concretas. Infinidad de acabados y posibilidades.

With an easy assembly, Evolum gives you the chance to adapt your dressing room to very specific needs. Multiple possibilities and finishing.

Fácil e simples na sua montagem, Evolum dá-lhe liberdade para adaptar seu vestíário a umas necessidades muito concretas. Uma infinidade de acabamentos e possibilidades.



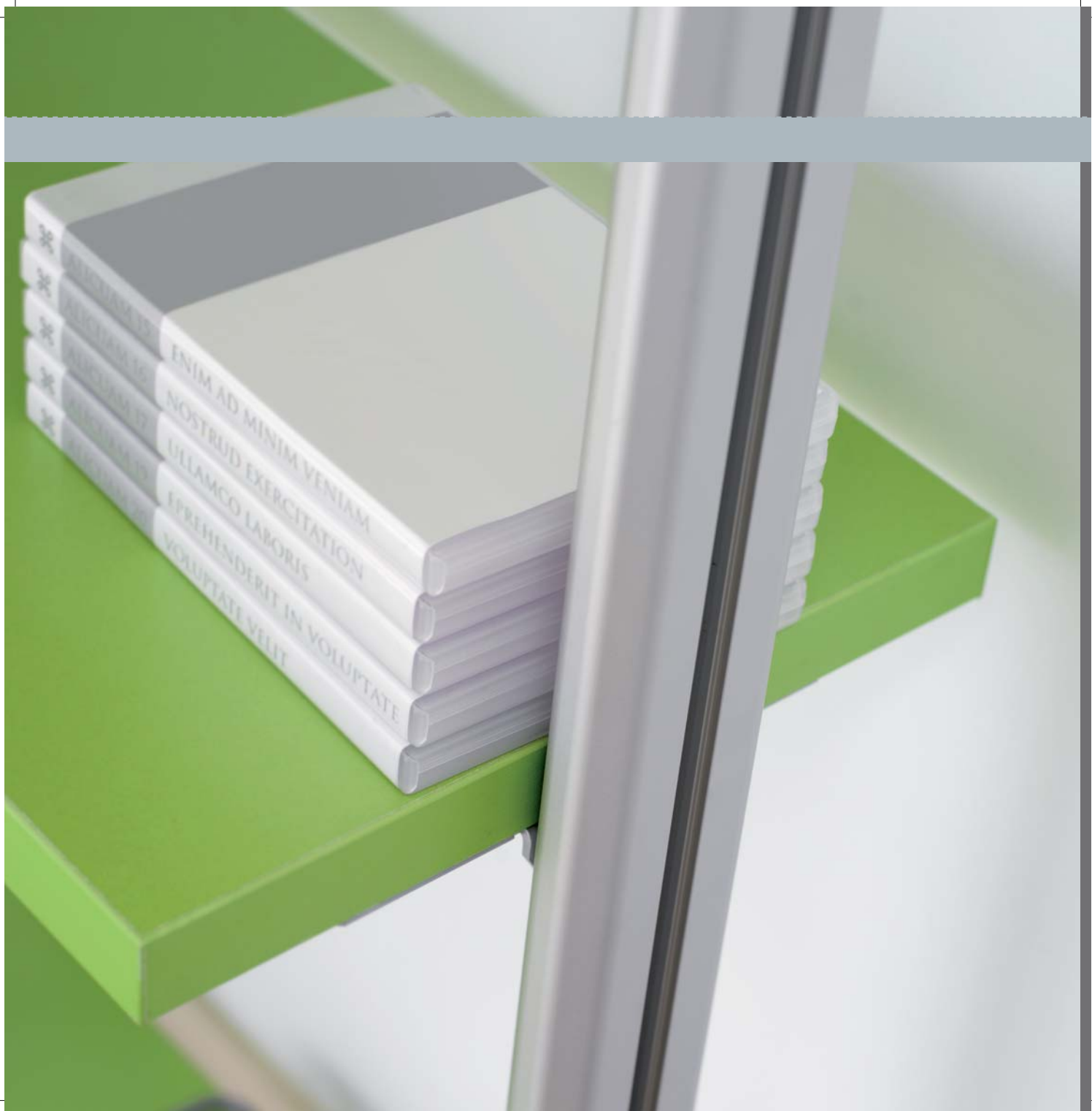

evolum_dormitorio juvenil
evolum_children bedroom
evolum_quarto juvenil

| evolum_dormitorio juvenil | evolum_children bedroom | evolum_quarto juvenil |





evolum_dormitorio juvenil

Evolum le ofrece la posibilidad de crear el ambiente íntimo y personal que requiere cada dormitorio. Diversidad de acabados que, combinados con las posibilidades de nuestro sistema, garantizan espacios únicos.

evolum_children bedroom

Evolum gives the chance of creating the familiar and personal environment required in every bedroom. Diverse finishing combined with our system guarantee singular spaces.

evolum_quarto juvenil

Evolum oferece-lhe a possibilidade de criar o ambiente íntimo e pessoal que requer cada quarto. Diversidade de acabamentos que combinados com as possibilidades do nosso sistema, garntem espaços únicos.

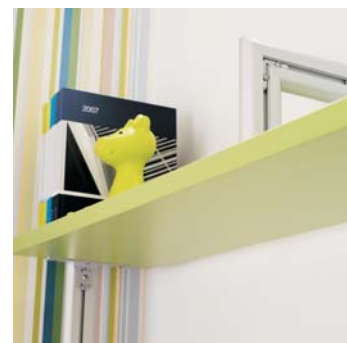

| evolum_dormitorio juvenil | evolum_children bedroom | evolum_quarto juvenil |



_infinidad de posibilidades que hacen de su espacio un lugar útil y acogedor
_Evolum endless possibilities will turn your room into a useful and snug space
_infinitude de possibilidades que fazem do seu espaço um lugar útil e acolhedor



Evolum es un sistema limpio, sencillo y al mismo tiempo robusto que da respuesta a una necesidad, a un espacio.
Evolum is a clean, simple and strong system able to cover your needs in every space.
Evolum é um sistema limpo, simples e ao mesmo tempo robusto que dá resposta a uma necessidade, a um espaço.





evolum_armario
evolum_wardrobe
evolum_roupeiro

| evolun_armario | evolun_wardrobe | evolun_roupeiro |





evolum_armario

Evolum le permite vestir el interior de armarios a medida, sin necesidad de complicados montajes in situ. Además, la posibilidad de emplear perfiles anclados de suelo a techo, permite una aprovechamiento del espacio óptimo.

evolum_wardrobe

Evolum allows you to decorate the interior of fitted wardrobes without complicated assemblies. In addition to a possibility of using fixed profiles from the floor to the ceiling, which offers you an optimized use of your space.

evolum_roupeiro

Evolum permite-lhe vestir o interior do roupeiro á medida, sem necessidade de montagens complicadas. Além disso a possibilidade de empregar perfis fixados do chão ao teto, permite um aproveitamento do espaço óptimo.



| evolum_armario | evolum_wardrobe | evolum_roupeiro |



_sobriedad y elegancia para sus espacios
_sobriety and elegance in your personal space
_sobriedade e elegância para seus espaços



Cuidada selección de nuestras piezas para garantizarle el mejor resultado.
A meticulous selection of our pieces to guarantee the best results.
Cuidada selecção de nossa peças para garantir-lhe o melhor resultado.



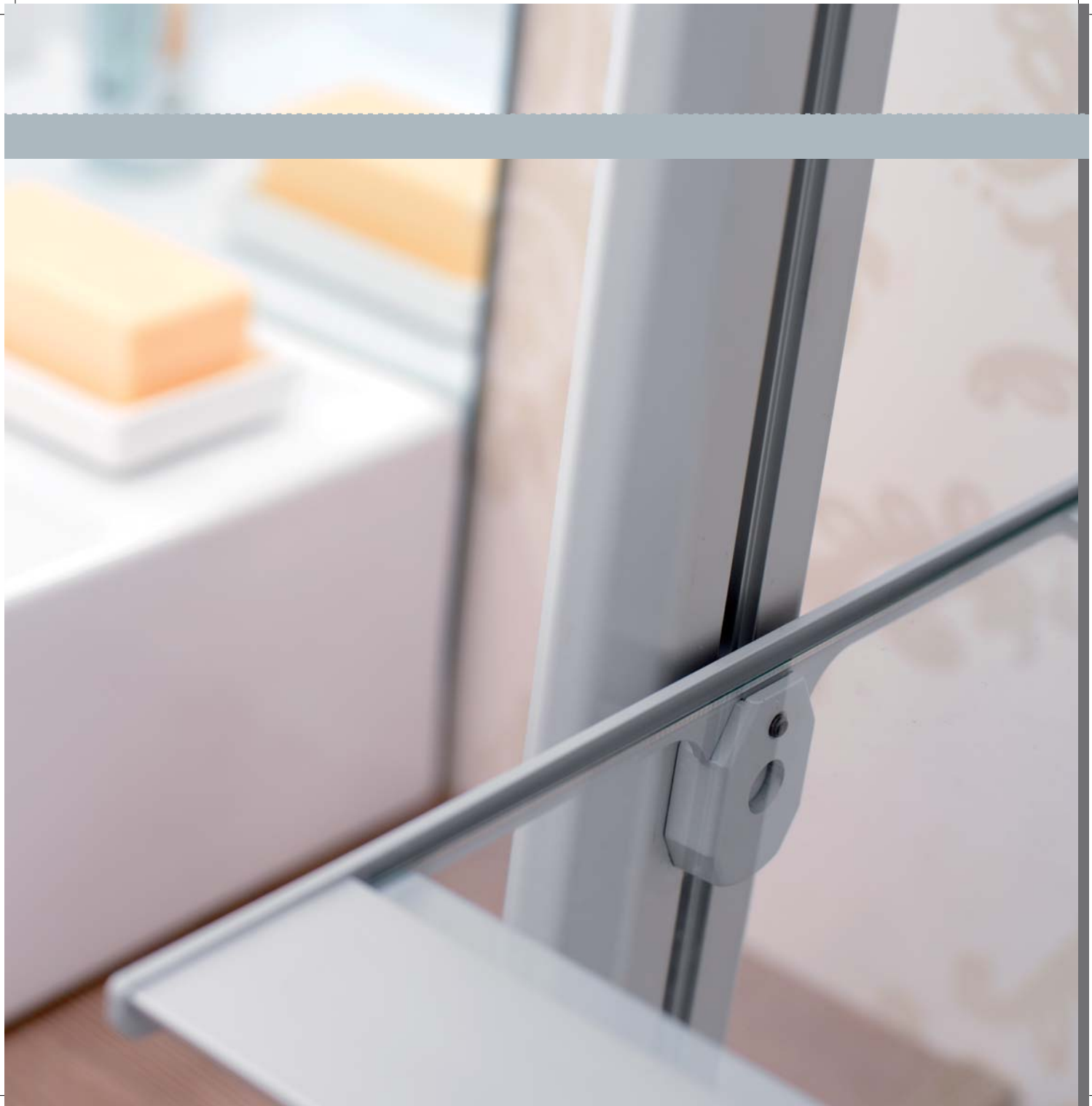

evolum_baño
evolum_bathroom
evolum_casa de banho

| evolum_baño | evolum_bathroom | evolum_casa de banho |





evolum_baño

La combinación de distintos acabados y la infinidad de posibilidades de nuestro sistema permiten la creación de espacios totalmente diferenciados e innovadores. Un claro ejemplo es el baño_evolum, espacio único que conjuga ambos aspectos a la perfección.

evolum_bathroom

The combination of different finishing and infinite possibilities in our system permit to create distinguished and innovative spaces. A clear example is our evolum_bathroom, a unique space which combines both features in a perfect way.

evolum_casa de banho

A combinação de diferentes acabamentos e a infinidade de possibilidades do nosso sistema permitem a criação de espaços totalmente diferenciados e inovadores. Um claro exemplo é um móvel de casa de banho evolum, espaço único que conjuga ambos os aspectos á perfeição.



| evolum_baño | evolum_bathroom | evolum_casa de banho |



_espacios que priman la accesibilidad y aprovechamiento del espacio
_spaces in which accessibility and a better use of themselves predominate
_ambientes que primam a acessibilidade e aproveitamento do espaço



Superficies duraderas y resistentes a ambientes húmedos.
Lasting and resistant surfaces to humid environments.
Superfícies duradouras e resistentes e ambientes húmidos.





evolum_oficina
evolum_office
evolum_escritório

| evolum_oficina | evolum_office | evolum_escritório |





evolum_oficina

En oficina, dada su diversidad e infinitas posibilidades, Evolum le permite diseñar un espacio de trabajo a su medida. Totalmente versátil y sencillo de montar, Evolum le garantiza personalización y exclusividad para su espacio. Infinidad de materiales, acabados... que harán de su oficina un lugar cómodo y funcional.

evolum_office

In the office, thanks to its diversity and multiple possibilities, Evolum allows to personalize your work place. Totally versatile and easy to assemble, Evolum guarantees you a personal and exclusive space. A large range of materials, finishing... which will transform your office into a comfortable and functional place.

evolum_escritório

No escritório, dada a sua diversidade e infinitas possibilidades, evolum permite-lhe desenhar um espaço de trabalho à sua medida. Totalmente versátil e simples de montar, Evolum garante personalização e exclusividade ao seu espaço. Infinitude de materiais, acabamentos... que farão do seu escritório um lugar cómodo e funcional.



| evolum_oficina | evolum_office | evolum_escritório |



_versatilidad y ligereza para espacios que cuidan el detalle
_versatility and lightness for those spaces in which details are important
_versatilidade e leveza para espaços que cuidam o detalhe

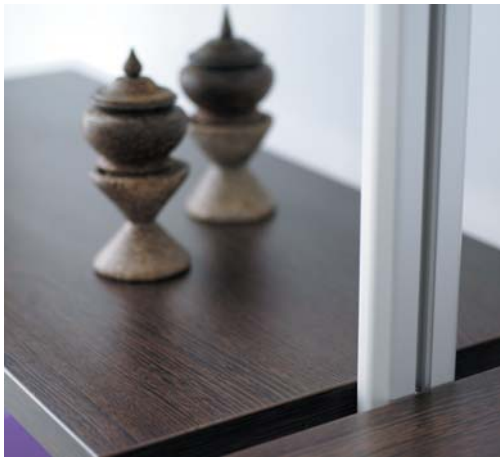

Las barras de aluminio aportan soluciones versátiles y personalizadas, además de favorecer la creación de oficinas con una estética sencilla, ligera y muy actual.
The aluminium bars provide adaptable and personalized solutions, in addition to the possibility of creating offices with a simple, light and modern aesthetic.
As barras de alumínio trazem soluções versáteis e personalizadas, além de favorecer a criação escritórios com uma estética simples, leve e muito actual.





evolum_componentes
evolum_components
evolum_componentes

Ref. 56.568.7027003

| Perfil Evolum | Evolum profile | Perfil Evolum |

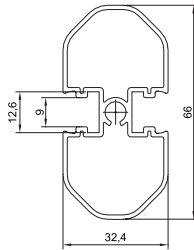
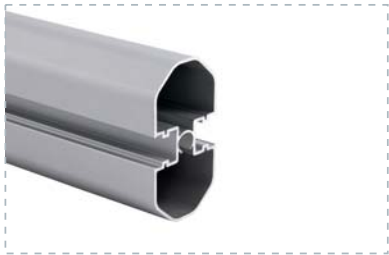

Material: aluminio
Acabado: anodizado plata mate
Longitud: 2700 mm.

Material: aluminium
Finishing: anodized matt silver
Length: 2700 mm.

Material: alumínio
Acabamento: anodizado prata mate
Comprimento: 2700 mm.

| Opciones de corte a medida | Options of fitted cuts | Opciones de corte a medida |

Ref. 56_X_70_L_3

L = Longitud perfil (mm) | Length of profile (mm) | Comprimento (mm) |

X = 550 / Corte recto | Straight cut | Corte recto |
 551 / Corte 1 inglete | Cut in one angle of 45° | Corte 45° |
 552 / Corte 2 ingletes | Cut in two angle of 45° | Corte 45° duplo |

A Techo | To ceiling | Teto |



Ref. 56.550.70_L_3

A Pared | To wall | Parede |

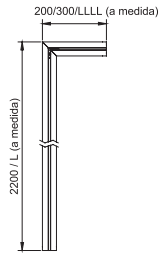

* Ref. 56.551.7022003
 * Ref. 56.551.7002003
 * Ref. 56.551.7003003
 Ref. 56.551.70_L_3

Isla | Isle | Ilha |

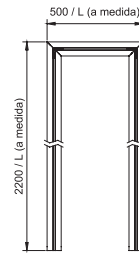

* Ref. 56.551.7022003
 Ref. 56.551.70_L_3
 * Ref. 56.552.7005003
 Ref. 56.552.70_L_3

* | estándar | standard | standard |

Ref. 56.567.040004

| Adaptador | Adapter | Adaptador |

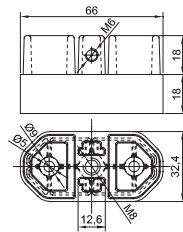

Material: zamac
Acabado: gris metalizado (RAL 9006)
Observaciones: pieza opcional con la cual se evita el roscado del perfil Evolum.

Material: zamac
Finishing: metallic-grey (RAL 9006)
Details: optional piece which avoids the threading in Evolum profile.

Material: zamac
Acabamento: cinzento metalizado (RAL 9006)
Observações: peça opcional com a qual se evita abrir rosca no perfil Evolum.

Ref. 56.563.040001

| Pata Niveladora | Adjustable height leg | Pé nivelador |

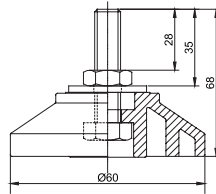

Material: poliamida reforzada / acero
Acabado: gris metalizado (RAL 9006)

Material: reinforced polyamide / steel
Finishing: metallic-grey (RAL 9006)

Material: poliamida reforçado / aço
Acabamento: cinzento metalizado (RAL 9006)

Ref. 56.564.040004

| Soporte pared / techo | Wall / ceiling support | Suporte parede / teto |

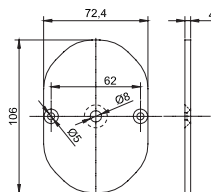

Material: acero
Acabado: gris metalizado (RAL 9006)

Material: steel
Finishing: metallic-grey (RAL 9006)

Material: aço
Acabamento: cinzento metalizado (RAL 9006)

Ref. 224040030000

| Escuadra_1 unión perfil | Bracket_1 profile joint | Esquadro _1 união de perfil |

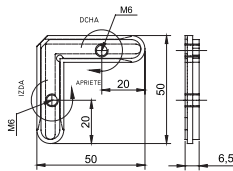

Material: zamac
Acabado: zincado
Observaciones: ajuste más rápido, sencillo y robusto.

Material: zamac
Finishing: zinc
Details: simple, resistant and quick adjustment.

Material: zamac
Acabamento: zincado
Observações: ajuste mais rápido, simples e robusto.

Ref. 56.565.0400004

| Escuadra_2 unión perfil | Bracket_2 profile joint | Esquadro _2 união de perfil |

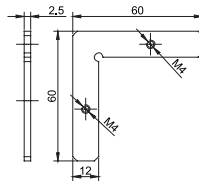

Material: acero
Acabado: gris metalizado (RAL 9006)

Material: steel
Finishing: metallic-grey (RAL 9006)

Material: aço
Acabamento: cinzento metalizado (RAL 9006)

Ref. 56.566.0400004

| Soporte antivuelco | Anti-sway support | Suporte anti-capotamento |

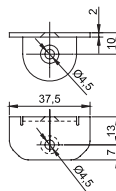

Material: acero
Acabado: gris metalizado (RAL 9006)

Material: steel
Finishing: metallic-grey (RAL 9006)

Material: aço
Acabamento: cinzento metalizado (RAL 9006)

Ref. 56.561.0402504

| Soporte estantes_1 | Shelf support_1 | Suporte de prateleiras_1 |

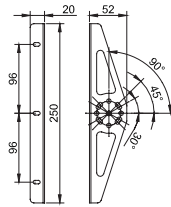
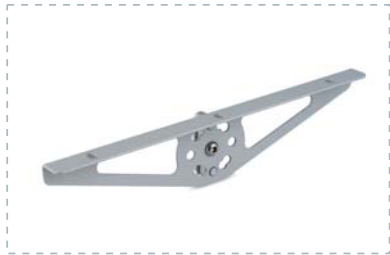

Material: acero
Acabado: gris metalizado (RAL 9006)
Material: steel
Finishing: metallic-grey (RAL 9006)
Material: aço
Acabamento: cinzento metalizado (RAL 9006)

Ref. 56.575.0401804

| Soporte estantes_2 | Shelf support_2 | Suporte de prateleiras_2 |

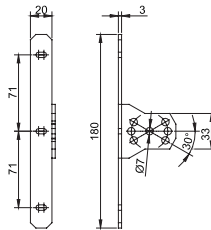

Material: acero
Acabado: gris metalizado (RAL 9006)
Material: steel
Finishing: metallic-grey (RAL 9006)
Material: aço
Acabamento: cinzento metalizado (RAL 9006)

Ref. 56.576.0401804

| Soporte estantes_3 | Shelf support_3 | Suporte de prateleiras_3 |

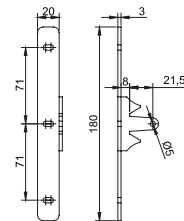

Material: zamac
Acabado: gris metalizado (RAL 9006)
Observaciones: montaje rápido y sencillo.
Material: steel
Finishing: metallic-grey (RAL 9006)
Details: easy and quick assembling.
Material: aço
Acabamento: cinzento metalizado (RAL 9006)
Observações: montagem mais rápida e simples.

Ref. 56.501.7040003

| Perfil estante aluminio_1 | Profile for aluminium shelf_1 | Perfil prateleira de aluminio _1 |

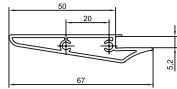

Material: aluminio
Acabado: anodizado plata mate
Longitud: 4000 mm.
Observaciones: permite la colocación de un tablero, cristal o metacrilato de hasta 5 mm.

Material: aluminium
Finishing: anodized matt silver
Length: 4000 mm.
Details: allows assembling a 5 mm thickness board, glass or methacrylate.

Material: alumínio
Acabamento: anodizado prata mate
Comprimento: 4000 mm.
Observações: permite la colocação de um placa, vidro o acrílico de até 5 mm.

Ref. 56.502.7040003

| Perfil estante aluminio_2 | Profile for aluminium shelf_2 | Perfil prateleira de aluminio_2 |

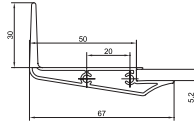

Material: aluminio
Acabado: anodizado plata mate
Longitud: 4000 mm.
Observaciones: permite la colocación de un tablero, cristal o metacrilato de hasta 5 mm.

Material: aluminium
Finishing: anodized matt silver
Length: 4000 mm.
Details: allows assembling a 5 mm thickness board, glass or methacrylate.

Material: alumínio
Acabamento: anodizado prata mate
Comprimento: 4000 mm.
Observações: permite la colocação de um placa, vidro o acrílico de até 5 mm.

Ref. 56.510.0403004

| Soporte estante_4 | Profile for aluminium shelf_4 | Suporte prateleira _4 |

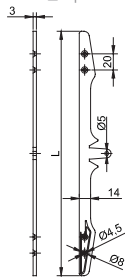

Material: acero
Acabado: gris metalizado (RAL 9006)
Observaciones: montaje rápido y sencillo. Para Ancho de balda 200, 350 y 500 mm.

Material: steel
Finishing: metallic- grey (RAL 9006)
Details: easy and quick assembling. Suitable for 200, 350 and 500 mm wide board.

Material: aço
Acabamento: cinzento metalizado (RAL 9006)
Observações: montagem rápida e simples. Para largura de prateleira 200, 350 e 500 mm.

Ref. 56.520.70 _ L _ 3

| Estante aluminio_1 fondo 200 | Aluminium shelf_1 for 200 depth | Prateleira de alumínio_1 fondo 200 |

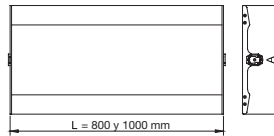

Material: aluminio
Acabado: anodizado plata mate
Anchura: 200 mm.
Observaciones: permite la colocación de un tablero, cristal o metacrilato de hasta 5 mm.

Material: aluminium
Finishing: anodized matt silver
Width: 200 mm.
Details: allows assembling a 5 mm thickness board, glass or methacrylate.

Material: alumínio
Acabamento: anodizado prata mate
Largura: 200 mm.
Observações: permite la colocação de um placa, vidro o acrílico de até 5 mm.

Ref. 56.523.70 _ L _ 3

| Estante aluminio_1 fondo 350 | Aluminium shelf_1 for 350 depth | Prateleira de alumínio_1 fondo 350 |

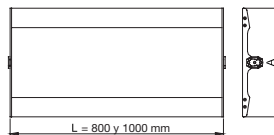

Material: aluminio
Acabado: anodizado plata mate
Anchura: 350 mm.
Observaciones: permite la colocación de un tablero, cristal o metacrilato de hasta 5 mm.

Material: aluminium
Finishing: anodized matt silver
Width: 350 mm.
Details: allows assembling a 5 mm thickness board, glass or methacrylate.

Material: alumínio
Acabamento: anodizado prata mate
Largura: 350 mm.
Observações: permite la colocação de um placa, vidro o acrílico de até 5 mm.

Ref. 56.526.70 _ L _ 3

| Estante aluminio_1 fondo 500 | Aluminium shelf_1 for 500 depth | Prateleira de alumínio_1 fondo 500 |

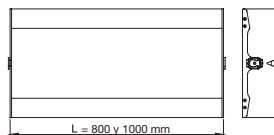
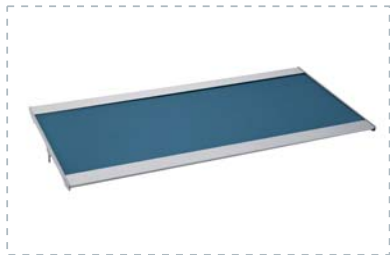

Material: aluminio
Acabado: anodizado plata mate
Anchura: 500 mm.
Observaciones: permite la colocación de un tablero, cristal o metacrilato de hasta 5 mm.

Material: aluminium
Finishing: anodized matt silver
Width: 500 mm.
Details: allows assembling a 5 mm thickness board, glass or methacrylate.

Material: alumínio
Acabamento: anodizado prata mate
Largura: 500 mm.
Observações: permite la colocação de um placa, vidro o acrílico de até 5 mm.

Ref. 56.530.70 _L_ 3

| Estante aluminio_2 fondo 200 | Aluminium shelf_2 for 200 depth | Prateleira de alumínio_2 fondo 200 |

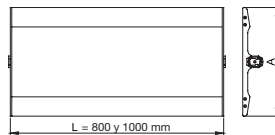
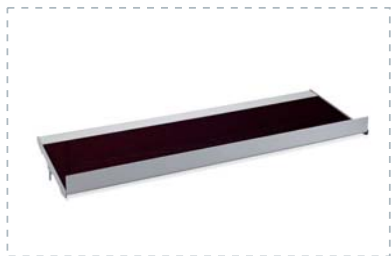

Material: aluminio
Acabado: anodizado plata mate
Anchura: 200 mm.
Observaciones: permite la colocación de un tablero, cristal o metacrilato de hasta 5 mm.

Material: aluminium
Finishing: anodized matt silver
Width: 200 mm.
Details: allows assembling a 5 mm thickness board, glass or methacrylate.

Material: alumínio
Acabamento: anodizado prata mate
Largura: 200 mm.
Observações: permite a colocação de um placa, vidro o acrílico de até 5 mm.

Ref. 56.533.70 _L_ 3

| Estante aluminio_2 fondo 350 | Aluminium shelf_2 for 350 depth | Prateleira de alumínio_2 fondo 350 |

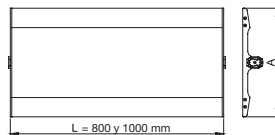

Material: aluminio
Acabado: anodizado plata mate
Anchura: 350 mm.
Observaciones: permite la colocación de un tablero, cristal o metacrilato de hasta 5 mm.

Material: aluminium
Finishing: anodized matt silver
Width: 350 mm.
Details: allows assembling a 5 mm thickness board, glass or methacrylate.

Material: alumínio
Acabamento: anodizado prata mate
Largura: 350 mm.
Observações: permite a colocação de um placa, vidro o acrílico de até 5 mm.

Ref. 56.536.70 _L_ 3

| Estante aluminio_2 fondo 500 | Aluminium shelf_2 for 500 depth | Prateleira de alumínio_2 fondo 500 |

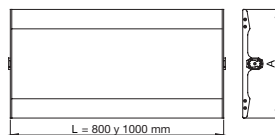
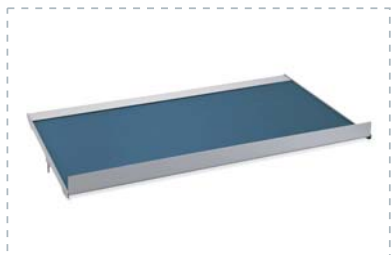

Material: aluminio
Acabado: anodizado plata mate
Anchura: 500 mm.
Observaciones: permite la colocación de un tablero, cristal o metacrilato de hasta 5 mm.

Material: aluminium
Finishing: anodized matt silver
Width: 500 mm.
Details: allows assembling a 5 mm thickness board, glass or methacrylate.

Material: alumínio
Acabamento: anodizado prata mate
Largura: 500 mm.
Observações: permite a colocação de um placa, vidro o acrílico de até 5 mm.

Ref. 56.540.70_L_3

| Estante aluminio con luz | Aluminium shelf with light | Prateleira de aluminio com luz |

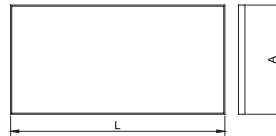

Material: aluminio y cristal o metacrilato
Acabado: anodizado plata mate
Anchura: 200, 350 y 500 mm.
Observaciones: permite la colocación de un metacrilato o cristal de 4 mm, así como el corte a medida tanto en longitud como en profundidad.

Material: aluminium and glass or methacrylate
Finishing: matt silver anodized
Width: 200, 350 y 500 mm.
Details: this item can be customized in length and depth, and allows assembling a 4 mm thickness, glass or methacrylate sheet.

Material: alumínio e vidro o metacrilato
Acabamento: anodizado prata mate
Largura: 200, 350 y 500 mm.
Observações: permite a colocação de um acrílico o vidro de 4 mm assim como o corte ao medida tanto em comprimento como em profundidade.

| Estante aluminio con luz | Aluminium shelf with light | Prateleira de aluminio com luz |

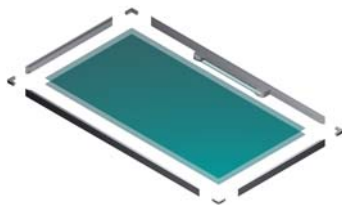

Las baldas de luz pueden combinarse con cristal o metacrilato de 4mm de espesor.

The light shelves can be used with 4mm thick glass or methacrylate.

As prateleiras com luz podem combinar-se com vidro o acrílico de 4mm de espesura.

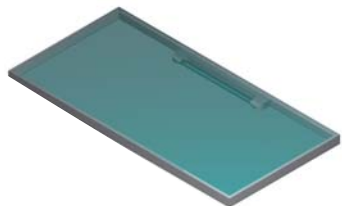
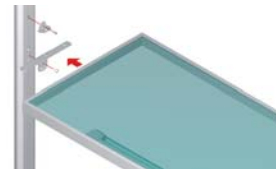

Las dimensiones de las baldas vienen definidas por unas medidas estándar, siendo la longitud y la anchura de las mismas adaptables bajo pedido a cualquier medida.

The dimensions of the shelves are established by standard measures but the length and the width can be custom-made on request.

As dimensões das prateleiras têm medidas Standard, sendo o comprimento e a largura adaptáveis sob encomenda a qualquer medida.

Montaje rápido y sencillo.

Easy and quick assembly system.

Montagem rápida e simples.

Posibilidad de rotación de la balda.

Tilt over feature.

Possibilidade de rodar a prateleira.

Ref. 56.581.0400004

| Soporte accesorios_1 | Accessories support_1 | Suporte accesorios_1 |

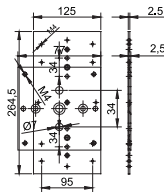

Material: acero
Acabado: gris metalizado (RAL 9006)
Observaciones: permite la colocación de accesorios Ego y Kósmica.

Material: steel
Finishing: metallic-grey (RAL 9006)
Details: allows Ego and Kósmica accessories assembly.

Material: aço
Acabamento: cinzento metalizado (RAL 9006)
Observações: permite a colocação de acessórios Ego e Kósmica.

Ref. 56.582.0400004

| Soporte accesorios_2 | Accessories support_2 | Suporte accesorios_2 |

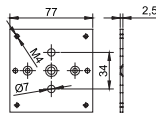

Material: acero
Acabado: gris metalizado (RAL 9006)
Observaciones: permite la colocación de accesorios Ego y Kósmica.

Material: steel
Finishing: metallic-grey (RAL 9006)
Details: allows Ego and Kósmica accessories assembly.

Material: aço
Acabamento: cinzento metalizado (RAL 9006)
Observações: permite a colocação de acessórios Ego e Kósmica.

| Soporte accesorios_1 | Accessories support_1 | Suporte accesorios_1 |



| Soporte accesorios_2 | Accessories support_2 | Suporte accesorios_2 |

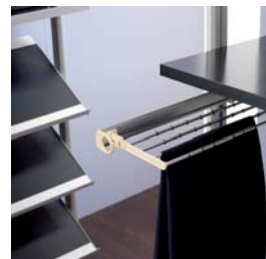

Ref. 56.580.040004

| Soporte frontal | Frontal support | Suporte frontal |

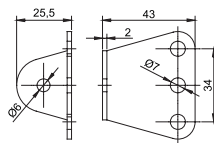

Material: acero
Acabado: gris metalizado (RAL 9006)
Observaciones: permite la colocación de un tablero o cristal frontalmente al perfil Evolum.

Material: steel
Finishing: metallic-grey (RAL 9006)
Details: allows a frontal board or glass sheet assembling to the Evolum profile.

Material: aço
Acabamento: cinzento metalizado (RAL 9006)
Observações: permite a colocação de uma estante ou vidro frontalmente ao perfil Evolum.

Ref. 656090430000

| Perfil tubo oval | Oval tube profile | Perfil tubo oval |

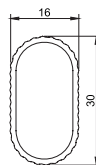

Material: aluminio
Acabado: anodizado plata mate
Longitud: 4000 mm.

Material: aluminium
Finishing: matt silver anodized
Length: 4000 mm.

Material: alumínio
Acabamento: anodizado prata mate
Comprimento: 4000 mm.

Ref. 56.570.040004

| Soporte lateral tubo oval | Oval tube lateral support | Suporte lateral tubo oval |

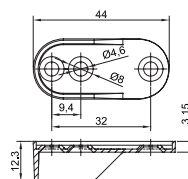

Material: zamac
Acabado: cromo mate

Material: zamac
Finishing: matt chrome

Material: zamac
Acabamento: cromado mate

| Pedidos estándar y corte a medida | Standard profiles and fitted cut | Encomendas Standard e cortadas á medida |

| ALTURA | HEIGHT | ALTURA |

| MEDIDAS ESTÁNDAR | STANDARD MEASURES | MEDIDAS STANDARD |

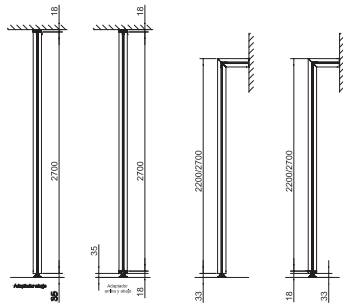

| CORTE A MEDIDA | FITTED CUT | CORTE A MEDIDA |

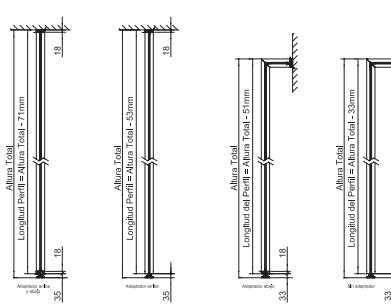

| LONGITUD | HEIGHT | COMPRIMENTO |

Todos los perfiles de aluminio pueden cortarse a medida para adecuarse a cualquier espacio y a cualquier balda.

All aluminium profiles can be fitted cut in order to be adapted to different spaces and shelves.

Todos os perfis de aluminio podem ser cortados á medida para se adequarem a qualquer espaço.

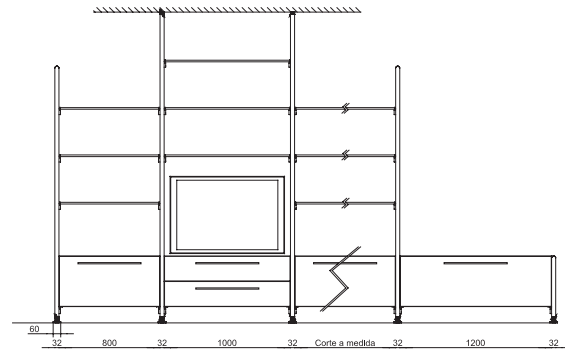

| PROFUNDIDAD | DEPTH | PROFUNDIDADE |

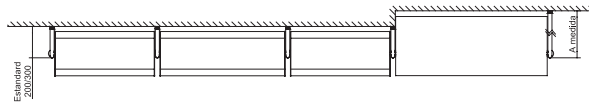

Las baldas de aluminio pueden combinarse con madera, cristal o metacrilato de 5 mm de espesor.

Aluminium shelves can be assembled with wood board, glass or methacrylate 5mm thickness sheet.

As prateleiras de alumínio podem ser combinadas com madeira, vidro ou acrílico de 5mm de espessura.

La profundidad de las baldas viene definida por unas medidas estándar. siendo la longitud de mismas adaptables bajo pedido a cualquier medida.

Shelves depth is standard; their length can be customized under previous request.

A profundidade das prateleiras vem definida por umas medidas Standard, sendo o comprimento das mesmas adaptáveis sob pedido a qualquer medida.

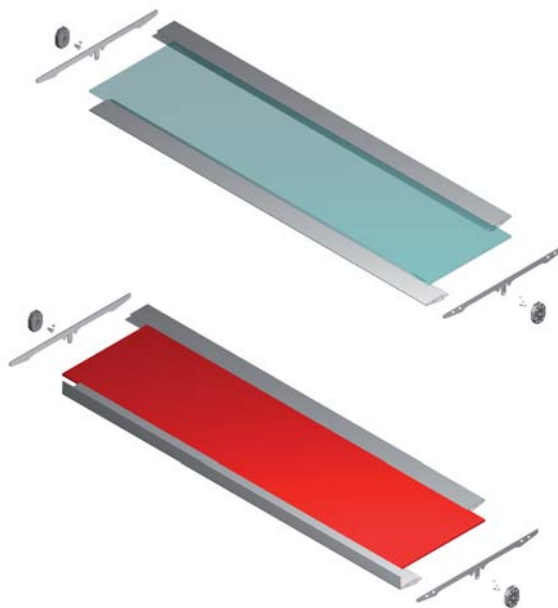

Montaje rápido y sencillo.
Easy and quick assembly system.
Montagem rápida e simples.

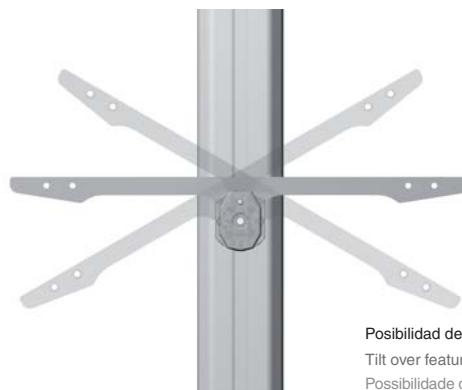

Posibilidad de rotar la balda.
Tilt over feature.
Possibilidade de rodar a prateleira.



Ref. 56.551.70____3	Ref. 56.566.0400004
Ref. 56.563.0400001	Ref. 656090430000
Ref. 56.564.0400004	Ref. 56.570.0040004
Ref. 56.565.0400004	
Ref. 56.561.0402504	

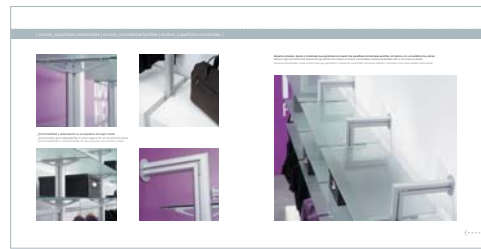

Ref. 56.551.70____3	Ref. 56.566.0400004
Ref. 56.563.0400001	Ref. 656090430000
Ref. 56.564.0400004	Ref. 56.570.0040004
Ref. 56.565.0400004	
Ref. 56.561.0402504	



Ref. 56.551.70____3	Ref. 656090430000
Ref. 56.567.0400004	Ref. 56.570.0040004
Ref. 56.563.0400001	Ref. 56.580.0400004
Ref. 224040030000	
Ref. 56.575.0401804	

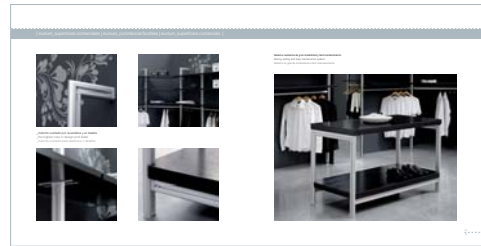

Ref. 56.551.70____3	Ref. 656090430000
Ref. 56.567.0400004	Ref. 56.570.0040004
Ref. 56.563.0400001	Ref. 56.580.0400004
Ref. 224040030000	
Ref. 56.575.0401804	



Ref. 56.551.70____3	Ref. 56.523.7010003
Ref. 56.567.0400004	Ref. 56.533.7010003
Ref. 56.563.0400001	Ref. 56.540.7010003
Ref. 224040030000	Ref. 56.580.0400004
Ref. 56.575.0401804	

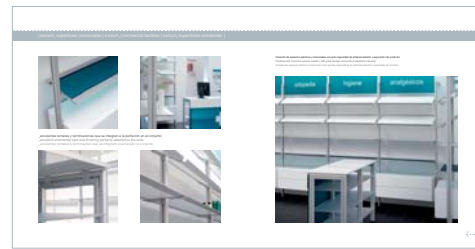

Ref. 56.551.70____3	Ref. 56.523.7010003
Ref. 56.567.0400004	Ref. 56.533.7010003
Ref. 56.563.0400001	Ref. 56.540.7010003
Ref. 224040030000	Ref. 56.580.0400004
Ref. 56.575.0401804	



Ref. 56.551.70____3 Ref. 56.566.0400004
Ref. 56.563.0400001
Ref. 56.564.0400004
Ref. 224040030000
Ref. 56.561.0402504

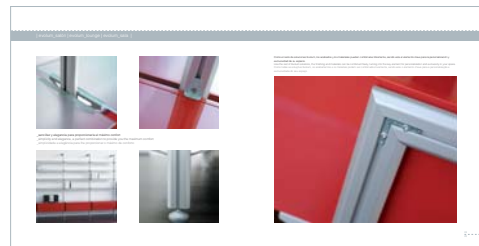

Ref. 56.551.70____3 Ref. 56.566.0400004
Ref. 56.563.0400001
Ref. 56.564.0400004
Ref. 224040030000
Ref. 56.561.0402504

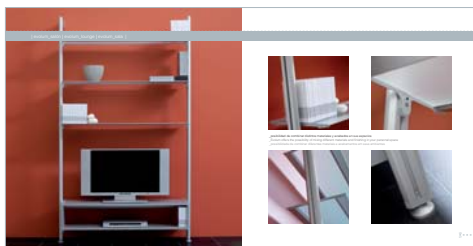

Ref. 56.551.70____3 Ref. 56.523.7010003
Ref. 56.567.0400004
Ref. 56.563.0400001
Ref. 224040030000
Ref. 56.575.0401804

| evolum_vestidor | evolum_dressing room | evolum_vestiário |

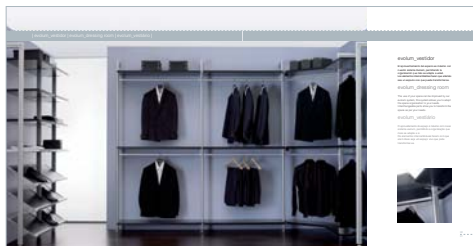

Ref. 56.551.70____3 Ref. 656090430000
 Ref. 56.567.0400004 Ref. 56.570.0040004
 Ref. 56.563.0400001 Ref. 56.536.7008003
 Ref. 224040030000 Ref. 56.540.7008003
 Ref. 56.575.0401804



Ref. 56.551.70____3 Ref. 656090430000
 Ref. 56.567.0400004 Ref. 56.570.0040004
 Ref. 56.563.0400001 Ref. 56.536.7008003
 Ref. 224040030000 Ref. 56.540.7008003
 Ref. 56.575.0401804



Ref. 56.551.70____3 Ref. 56.566.0400004
 Ref. 56.563.0400001 Ref. 656090430000
 Ref. 56.564.0400004 Ref. 56.570.0040004
 Ref. 224040030000
 Ref. 56.561.0402504

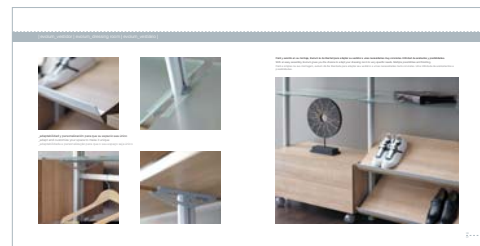

Ref. 56.551.70____3 Ref. 56.566.0400004
 Ref. 56.563.0400001 Ref. 656090430000
 Ref. 56.564.0400004 Ref. 56.570.0040004
 Ref. 224040030000
 Ref. 56.561.0402504

| evolum_dormitorio juvenil | evolum_children bedroom | evolum_quarto juvenil |



Ref. 56.551.70_3
 Ref. 56.567.0400004
 Ref. 56.563.0400001
 Ref. 224040030000
 Ref. 56.575.0401804

Ref. 56.551.70_3
 Ref. 56.567.0400004
 Ref. 56.563.0400001
 Ref. 224040030000
 Ref. 56.575.0401804

| evolum_armario | evolum_wardrobe | evolum_roupeiro |

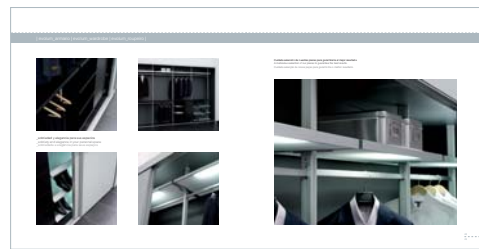

Ref. 56.550.70_3 Ref. 56.536.7008003
 Ref. 56.567.0400004 Ref. 656090430000
 Ref. 56.563.0400001 Ref. 56.570.0040004
 Ref. 224040030000 Ref. 56.560.7008003
 Ref. 56.575.0401804

Ref. 56.550.70_3 Ref. 56.536.7008003
 Ref. 56.567.0400004 Ref. 656090430000
 Ref. 56.563.0400001 Ref. 56.570.0040004
 Ref. 224040030000 Ref. 56.560.7008003
 Ref. 56.575.0401804

| evolun_baño | evolun_bathroom | evolun_casa de banho |



Ref. 56.551.70____3 Ref. 656090430000
 Ref. 56.567.0400004 Ref. 56.570.0040004
 Ref. 56.563.0400001
 Ref. 224040030000
 Ref. 56.523.70____3

Ref. 56.551.70____3 Ref. 656090430000
 Ref. 56.567.0400004 Ref. 56.570.0040004
 Ref. 56.563.0400001
 Ref. 224040030000
 Ref. 56.523.70____3

| evolun_oficina | evolun_office | evolun_escritório |

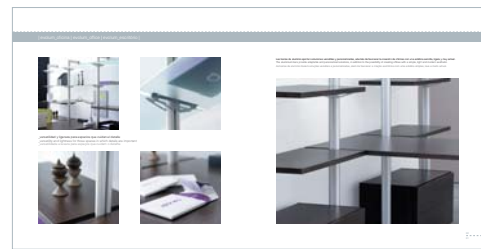

Ref. 56.551.70____3 Ref. 56.566.0400004
 Ref. 56.563.0400001
 Ref. 56.564.0400004
 Ref. 224040030000
 Ref. 56.561.0402504

Ref. 56.551.70____3 Ref. 56.566.0400004
 Ref. 56.563.0400001
 Ref. 56.564.0400004
 Ref. 224040030000
 Ref. 56.561.0402504









idónea

Políg. Valdeconsejo, C/ Peña Oroel, Parcela A. 50410. Cuarte de Huerva. Zaragoza. SPAIN
Telf./ +34 976 504 066 Fax/ +34 976 505 415
www.idoneasystem.com E-mail:idonea@idoneasystem.com